

**Lighting Solutions**  
Recessed downlighting products

**HALO**



**EATON**

*Powering Business Worldwide*

# HALO HOME™

## Smart solutions for a connected home

Eaton's **Halo Home** offers Bluetooth enabled lighting and controls products that can be easily configured by using a smartphone or tablet. The system allows the user to securely connect, automate and control a variety of lighting and controls products throughout the interior and exterior of the home.

- Connects the power of HALO
- Simple configuration by using a smartphone or tablet
- System is fully functional with or without the internet
- Flexible features that can provide user satisfaction and true energy savings

● **Connect,  
automate  
and control  
your homes  
lighting**

Connect the power of HALO.



Wireless LED  
downlights



Dimmers /  
switches



Internet access  
bridge



Mobile  
applications



**HALO**  
Market-leader  
residential  
lighting



Light

Power

Connect



Search for "Halo Home"  
in your app store.

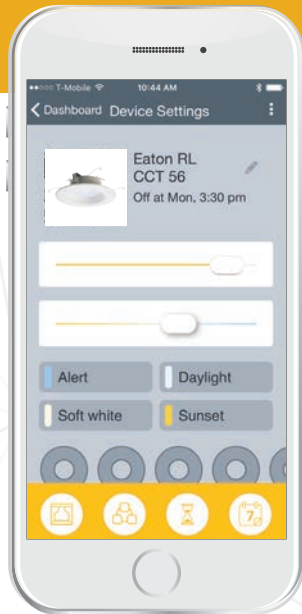

On/Off/Dim



Grouping



Scheduling



Adjustable Color  
Temperature  
(2700K - 5000K)





Mix and match Halo Home products to personalize your lighting.



4" and 5" / 6"  
Halo LED downlights



internet access bridge



works with Echo  
(Alexa)



anyplace bluetooth  
dimmer switch



# HALO<sup>®</sup> Connect

## RL Zigbee wireless

4", 5"/6" LED retrofit downlight

### Automate and control lighting remotely

Set automations or scheduled actions through the hub app. Geofencing also available through the app.

### Color adjustment

Adjust color temperature (CCT) using the hub app. 2700K (warm) - 5000K (cool)

### Create scenes by grouping

Choose multiple Halo RL wireless downlights and control them all together using the hub app.

### ON/OFF functions

Perform ON/OFF functions from anywhere.

### Dimming function

The downlight will dim to 5% using the hub app. Do not connect the downlight to a wall dimmer.

### Uses ZigBee

Smart device and **hub required**. Sold separately.

- Compatible with Wink and SAMSUNG SmartThings.
- Works directly with Echo Plus with built-in hub.





2700K

adjustable color temperature range

5000K



**Halo LED Downlight**  
wireless controlled



**Hub**  
- Compatible with Wink Hub 2 and SAMSUNG SmartThings  
- Works with Echo Plus with built-in hub

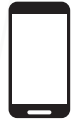

**Smart device**  
Virtual assistant or smart device



## RL

### 4" and 5"/6" LED retrofit downlight

The Halo RL LED is a complete 4" and 5"/6" LED baffle-trim module for recessed downlights. The RL is designed for use in new construction, remodel, and retrofit installation in Halo and other compatible 4", 5" and 6" recessed downlight housings. The integral LED driver offers 120 volt dimming capability. RL56 is offered in 600, 900, and 1200 lumen series. Suitable for use in clothes closets when installed with NEC® 410.16 spacing requirements.

RL models in 90 CRI are offered in 2700K, 3000K, 3500K, 4000K, and 5000K. Optional accessories include designer trims in white (paintable), satin nickel, and tuscan bronze.





**RL4**



**RL460WH9xxPK** 4" retrofit baffle/trim LED module, 90 CRI



**RL56**  
600, 900 and 1200 Series



- 600 lumen**
- RL560WH69xx** 5"/6" retrofit baffle/trim LED module, 90 CRI
- 900 lumen**
- RL560WH99xx** 5"/6" retrofit baffle/trim LED module, 90 CRI
- 1200 lumen**
- RL560WH129xx** 5"/6" retrofit baffle/trim LED module, 90 CRI

**xx** - **27**=2700K, **30**=3000K, **35**=3500K, **40**=4000K, **50**=5000K



**HE26LED**  
Edison Base Adapter  
for retrofit (included)

## Designer trims (order separately)

### Baffle



**RL4TRMWHB**  
**RL56TRMWHB**  
white (paintable)

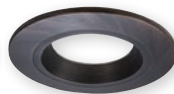

**RL4TRMTBZB**  
**RL56TRMTBZB**  
tuscan bronze

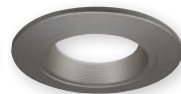

**RL4TRMSNB**  
**RL56TRMSNB**  
satin nickel

### Splay

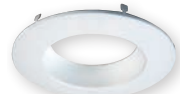

**RL4TRMWH**  
**RL56TRMWH**  
white (paintable)



**RL4TRMTBZ**  
**RL56TRMTBZ**  
tuscan bronze



**RL4TRMSN**  
**RL56TRMSN**  
satin nickel



## RA

### 4" and 5"/6" LED retrofit adjustable gimbal

The Halo RA LED is a complete 4" and 5"/6" adjustable gimbal LED module; suitable for new construction, remodel, and retrofit installation in Halo and other compatible 4", 5" and 6" recessed downlight housings. The RA adjustable gimbal offers 35-degree tilt and up to 360-degree rotation. The integral LED driver offers 120 volt dimming capability. The RA4 and RA56 adjustable gimbals are offered with 90 CRI in 2700K and 3000K; and with beam spread options in Very Wide Flood (VWFL) and Narrow Flood (NFL) models.



## Narrow Flood (NFL)



**RA4069xxNFLWH**

4" adjustable gimbal, 90 CRI, narrow flood



**RA56069xxNFLWH**

5"/6" adjustable gimbal, 90 CRI, narrow flood

## Very Wide Flood (VWFL)

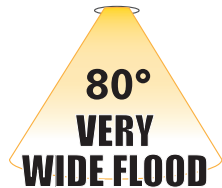

**RA4069xxWH**

4" adjustable gimbal, 90 CRI, very wide flood



**RA56069xxWH**

5"/6" adjustable gimbal, 90 CRI, very wide flood



**xx - 27=2700K, 30=3000K**



## LT

### 4" and 5" / 6" LED retrofit baffle trim kit

The Halo LT combines the energy savings, long life and sustainability of LED in an easy to install retrofit baffle trim kit. The LT is designed for use in new construction, remodel, and retrofit installation in Halo and other compatible 4", 5" and 6" recessed downlight housings. The diffuse lens provides shielding to the source and wet location listing; suitable for use in showers or in outdoor covered ceiling applications. Suitable for use in clothes closets when installed with NEC® 410.16 spacing requirements. Integral driver provides 120 volt phase cut dimming, an inline connector provides power using a medium base socket adapter provided or connect directly to the mating connector in the LED housings. LT models in 90 CRI are offered in 2700K, 3000K, 3500K, 4000K, and 5000K. Ships with a gasket and makes any housing airtight for added energy savings and code compliance.







LT4

*Slidewright*



LT56

*Slidewright*



**HE26LED**

Edison Base Adapter  
for retrofit (included)

**LT40WH69xx** 4" retrofit baffle/trim LED module, 90 CRI

**LT560WH69xx** 5"/6" retrofit baffle/trim LED module, 90 CRI

**xx - 27=2700K, 30=3000K, 35=3500K, 40=4000K, 50=5000K**



## ML4

### 4-inch LED downlighting system

The ML4 system is comprised of a housing, LED module, and round or square 2-inch aperture pinhole trims. This compact assembly installs from below the ceiling in standard 4-inch line voltage housings suitable for 2x6 residential framing or commercial construction (H995 housing series).

For even tighter spaces, ultra-shallow new construction and remodel (install from below) housings are available and are suitable for 2x4 framing (H245 series). For ceiling types that make recessed lighting difficult, like concrete pour, round and surface cylinders support direct attachment to finished ceiling surfaces.

Although diminutive in size the 900 lumen series ML4 delivers powerful beams of light providing the optical control and color quality typically associated with low voltage tungsten-halogen MR16 lamps. Delivered center beam candlepower (CBCP) of ML4 LED exceeds 50W low voltage MR16 lamps with significantly higher candela per watt (Cd/W).





**TIR50NFL25**  
25 degree  
narrow flood



**TIR50FL40**  
40 degree  
flood



**TIR50WFL55**  
55 degree  
wide flood



**TIR50AWW25**  
asymmetric wall wash



**LH501MB**  
Media holder for  
50mm lens



*media holder with lens  
installed on optic*

The narrow flood optic, the most efficient and powerful beam, is pre-installed in the ML4 module and is suitable for a wide range of applications. Alternate beams are possible – flood and wide flood optics are available as accessories and easily installed in the field. An optional media holder attaches directly to the optic and accepts industry standard 2" diameter (50mm) lens media providing additional creative control.



## ML4 LED module and trims



### ML4D09NFL9xxE

LED light engine

(interchangeable trim and optic options)

xx - 27=2700K, 30=3000K, 35=3500K, 40=4000K

### Compatible LED housings

H995ICAT - ICAT new construction, 120V

H995RICAT - ICAT remodel, 120V

H245ICAT - ICAT ultra-shallow new construction, 120V

H245RICAT - ICAT ultra-shallow remodel, 120V

### Surface housings

HS4Rxx - Surface round, 120-277V

HS4Sxx - Surface square, 120-277V

xx - MW=matte white, MB=matte black



## Open pinhole

### TL41R

2" round open pinhole



#### TL41RMW

matte white flange



#### TL41RBN

brushed nickel flange



#### TL41RBCu

brushed copper flange



#### TL41RMB

matte black flange



#### TL41RORB

oil rubbed bronze flange



#### TL41RGB

german bronze flange

### TL42S

2" square open pinhole

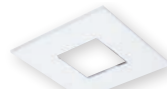

#### TL42RMW

matte white flange

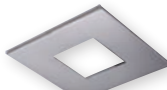

#### TL42RBN

brushed nickel flange

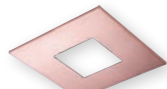

#### TL42RBCu

brushed copper flange



#### TL42RMB

matte black flange

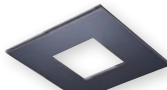

#### TL42RORB

oil rubbed bronze flange

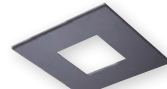

#### TL42RGB

german bronze flange

TL4 series trims are offered in four luxurious electro-plated finishes; brushed nickel, oil rubbed bronze, brushed copper and German bronze. Use to complement your thoughtfully selected interior finishes.

The TL4 trims are available in three trim types; open, lens, and lens wall wash.

The trims are attached by four powerful rare earth Neodymium magnets; they float on a bubble of magnetic flux keeping the trims held securely in place.

**TL43R**

2" round lens pinhole



**TL43R2GMWBB**  
matte white flange, white lens frame



**TL43R2GMBBB**  
matte black flange, black lens frame



**TL43R2GMWBB**  
matte black flange, black lens frame



**TL43R2GORBBB**  
oil rubbed bronze flange, black lens frame



**TL43R2GBNBB**  
brushed nickel flange, black lens frame



**TL43R2GGBBB**  
german bronze flange, black lens frame



**TL43R2GBCuBB**  
brushed copper flange, black lens frame

**TL42S**

2" square open pinhole

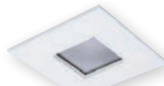

**TL44S2GMWBB**  
matte white flange, white lens frame

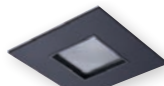

**TL44S2GMBBB**  
matte black flange, black lens frame



**TL44S2GMWBB**  
matte black flange, black lens frame

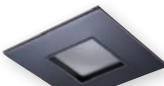

**TL44S2GORBBB**  
oil rubbed bronze flange, black lens frame

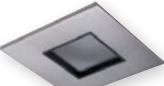

**TL44S2GBNBB**  
brushed nickel flange, black lens frame

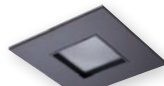

**TL44S2GGBBB**  
german bronze flange, black lens frame

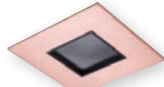

**TL44S2GBCuBB**  
brushed copper flange, black lens frame

**TL45R**

2" round lens wall wash



**TL45R6GMWBB**  
matte white flange, white lens frame



**TL45R6GMWBB**  
matte white flange, black lens frame

**TL46S**

2" round lens wall wash



**TL46S6GMWBB**  
matte white flange, white lens frame



**TL46S6GMWBB**  
matte white flange, black lens frame

**4" ultra-shallow LED housings**



**H2451CAT**  
4" ICAT ultra-shallow new construction



**H2451RICAT**  
4" ICAT ultra-shallow remodel



## ML56

### 5-inch / 6-inch LED downlighting system

The Halo ML56 LED downlight collection is comprised of LED modules with 5" and 6" trims. ML56 LED modules are offered in three lumen packages across the 600, 900, and 1200 series. For general lighting in commercial and residential applications for either new construction or retrofit existing 5" and 6" compatible housings. Halo LED ML56 features excellent color (80 CRI or 90 CRI) and offers a wide selection of color temperatures (2700K, 3000K, 3500K, and 4000K). An optional dim-to-warm (D2W™) feature creates an additional lighting solution as it provides a smooth warm transition from 3000K to 1850K when dimmed.





HALO Housing

HALO ML56 LED Light Module (600 or 900 Series)

HALO ML56 LED Light Module (1200 Series)

OR



optional NFL lens† (1200 Series)



HALO ML56 LED Trim

\*HE26LED Edison Screw Base Adapter (included for retrofit of non-LED housings).

†Optional accessory for the ML56-1200 series.

## ML56 LED Modules

### 600 or 900 Series



#### 600 lumen

**ML56068xx** 5"/6" LED light module, 600 lumen, 80 CRI

**ML56069xx** 5"/6" LED light module, 600 lumen, 90 CRI

#### 900 lumen

**ML56098xx** 5"/6" LED light module, 900 lumen, 80 CRI

**ML56099xx** 5"/6" LED light module, 900 lumen, 90 CRI

#### Dim-to-warm

**ML5606D2W930** 5"/6" dim-to-warm LED light module, 600 lumen, 90 CRI, 3000K to 1850K

**ML5609D2W930** 5"/6" dim-to-warm LED light module, 900 lumen, 90 CRI, 3000K to 1850K



\*

### 1200 Series



#### 1200 lumen

**ML56128xx** 5"/6" LED light module, 1200 lumen, 80 CRI

**ML56129xx** 5"/6" LED light module, 1200 lumen, 90 CRI

#### Dim-to-warm

**ML5612D2W930\*\*** 5"/6" dim-to-warm LED light module, 1200 lumen, 90 CRI, 3000K to 1850K



\*\*Beam forming optics/media not recommended for use with ML5612D2W930 LED module.

xx - 27=2700K, 30=3000K, 35=3500K, 40=4000K, 50=5000K

### 1200 Series Accessories



standard diffusing lens (included)



**BFR56NFL†** narrow flood lens (NFL)



**BFR56MH†** media holder (requires BFR56NFL & L345SF, ordered separately)

**L345SF** soft focus lens (requires BFR56NFL & BFR56MH, ordered separately)

## ML56 5" trims

**592**  
reflector



**592W**  
white



**592SC**  
specular clear



**592H**  
haze

**593**  
baffle



**593WB**  
white baffle and trim

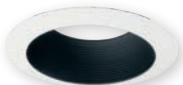

**593BB**  
black baffle, white trim

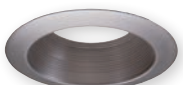

**593SN**  
satin nickel baffle and trim

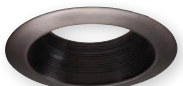

**593TBZ**  
tuscan bronze baffle and trim

**596**  
shallow baffle



**596WB**  
white baffle and trim

**591** non-conductive  
"dead front" baffle



**591WB**  
white baffle and trim  
(for 600 Series module only)

**594**  
semi-regressed eyeball



**594WB**  
white



**594SN**  
satin nickel



**594TBZ**  
tuscan bronze

**595**  
wall wash



**595WW**  
white trim ring

5" oversize trim ring



**TRM590WH**  
white



## ML56 6" trims

**692**  
reflector



**692W**  
white

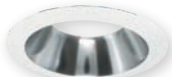

**692SC**  
specular clear



**692H**  
haze

**693**  
baffle



**693WB**  
white baffle and trim

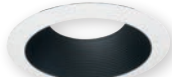

**693BB**  
black baffle, white trim

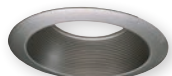

**693SN**  
satin nickel baffle and trim



**693TBZ**  
tuscan bronze baffle and trim

**696**  
shallow baffle



**696WB**  
white baffle and trim

**691** non-conductive  
"dead front" baffle



**691WB**  
white baffle and trim  
(for 600 Series module only)

**694**  
semi-regressed eyeball



**694WB**  
white



**694SN**  
satin nickel



**694TBZ**  
tuscan bronze

**695**  
wall wash



**695WW**  
white trim ring

6" oversize trim ring



**TRM690WH**  
white

## LED housings

4-inch, 5-inch, 6-inch

Halo offers dedicated LED new construction and remodel housings in 4-inch, 5-inch and 6-inch apertures. The Halo LED housings are designed for compatible use with designated Halo LED modules. Housings are designed for insulated ceilings and can be in direct contact with ceiling insulation\*. The AIRTITE housing design prevents airflow between conditioned and unconditioned spaces and saves on both heating and air conditioning spaces. The LED connector offers quick plug-in installation and high efficacy code compliance when used with designated Halo LED modules and trims.

## 4" housings

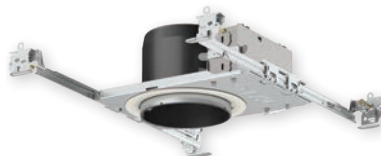

### H245ICAT

4" ICAT ultra-shallow new construction, air-tite



### H245RICAT

4" ICAT ultra-shallow remodel, air-tite

## compatible Halo LED modules



RL4



RA4



LT4



ML4  
with trims



SMD4



SLD4

## 5" housings



### E550ICAT

5" ICAT LED new construction, air-tite



### E550RICAT

5" ICAT LED remodel, air-tite

### compatible Halo LED modules



RL56



LT56



RA56



ML56  
with 5-inch trims



SMD6



SLD6



## 6" housings



**E750ICAT**  
6" ICAT LED new construction, air-tite



**E750RICAT**  
6" ICAT LED remodel, air-tite



**H2750ICAT**  
6" ICAT LED shallow new construction, air-tite



**H2750RICAT**  
5" ICAT LED shallow remodel, air-tite

---

### compatible Halo LED modules



RL56



LT56



RA56



ML56  
with 6-inch trims



SMD6



SLD6



## Halo Exclusive Features

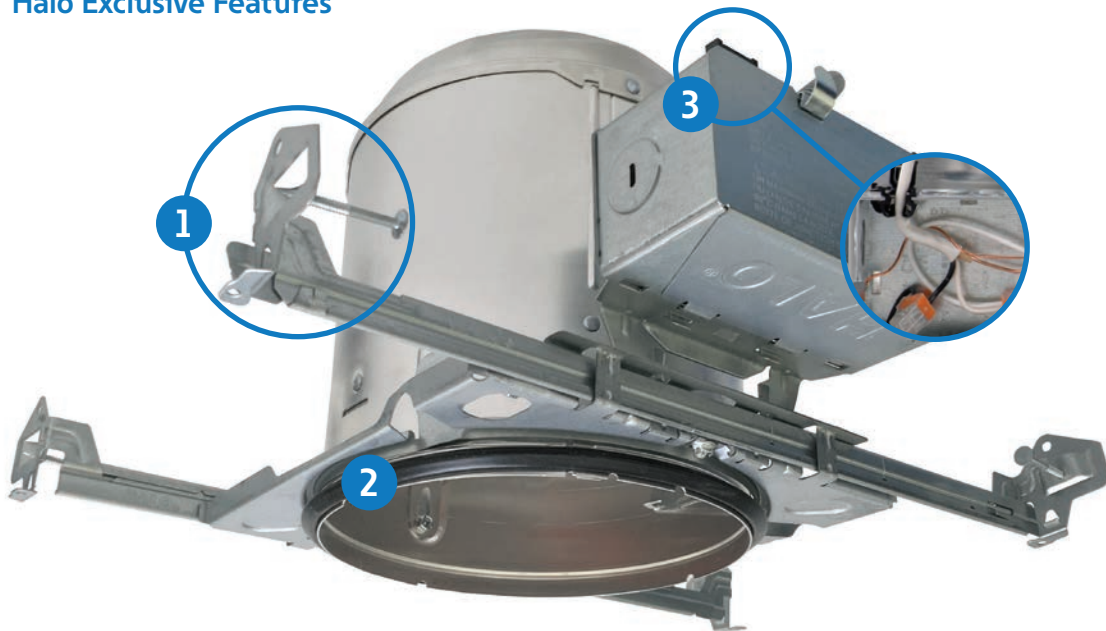

### 1. All-Nail bar hangers

- Integral nail angled to accommodate ease of installation
- Q-channel interlocking bars for secure adjustment
- Pass-N-Thru feature allows bars to pass through each other for adjustment and tool-less shortening without removal

### 2. AIR-TITE gasket

- Pre-installed compression gasket with a special can design that limits airflow and seals the can, frame & ceiling
- No additional gaskets or caulk required - saving installation time and money
- Tested to ASTM-E283-04 standard

### 3. Slide-N-Side junction box

- Hinged captive cover, box repositionable on the frame to clear obstructions
- Slide-N-Side wire traps and quick connects allow non-metallic sheathed cable to be installed outside the box, without tools and without removing knockouts.
- Accommodates standard non-metallic sheathed cable:
  - U.S.: #14/2, #14/3, #12/2, #12/3
  - Canada: #14/2, #14/3, #12/2

## SMD

### Surface mount LED downlighting

The Halo Surface Mount LED Downlight (SMD) is an ultra-low profile surface mounting luminaire with a modern look and high performance. SMD4 (4") and SMD6 (6") are designed for installation in recessed housings and many 3-1/2" and 4" square, octagon, or round junction boxes. Suitable for use in clothes closets when installed with NEC® 410.16 spacing requirements. The SMD series also offers a direct mount (DM) version which can be installed directly into the ceiling with no additional junction box or housing required. Utilizing the integral Halo enclosure, the DM version of the SMD provides a quick installation and flush finish with the ceiling.





### SMD

housing and junction box compatible



- SMD4R69xxWH** 4" Round surface mount LED downlight, 90 CRI
- SMD4S69xxWH** 4" Square surface mount LED downlight, 90 CRI
- SMD6R69xxWH** 6" Round surface mount LED downlight, 90 CRI
- SMD6S69xxWH** 6" Square surface mount LED downlight, 90 CRI

**xx** - 27=2700K, 30=3000K, 35=3500K, 40=4000K, 50=5000K



### SMD-DM

direct mount into ceiling; no housing or jbox needed



- SMD4R69xxWHDM** 4" Round surface mount LED downlight, 90 CRI, direct mount
- SMD4S69xxWHDM** 4" Square surface mount LED downlight, 90 CRI, direct mount
- SMD6R69xxWHDM** 6" Round surface mount LED downlight, 90 CRI, direct mount
- SMD6S69xxWHDM** 6" Square surface mount LED downlight, 90 CRI, direct mount

**xx** - 27=2700K, 30=3000K, 35=3500K, 40=4000K, 50=5000K





## SMD

- Fits most j-boxes and 5-inch or 6-inch recessed housings
- Ceiling or wall mounting in compatible junction boxes
- Replaces bulbs, flush mounts, and recessed trims



### mounting methods



Junction box bracket



Torsion springs for recessed housings



Friction clips for recessed housings

### SMD Designer Trims (sold separately)

- Exclusively for use with Halo SMD4 and SMD6 LED modules
- Round or square trims
- Finishes: white (paintable), satin nickel, tuscan bronze

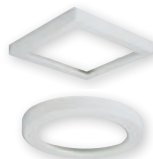

SMDxSTRMWH  
SMDxRTRMWH



SMDxSTRMSN  
SMDxRTRMSN

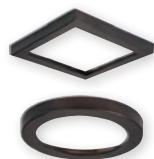

SMDxSTRMTBZ  
SMDxRTRMTBZ



## SMD-DM

- Install into drywall without a housing or junction box
- Integral junction box
  - (2) conduit knock-outs
  - (2) Slide-N-Side™ wire traps



### easy installation



1. Cut a hole in drywall with the provided template.



2. Wire to the integrated fixture junction box.



3. Fold both of the spring clips upward.



4. Push the fixture up into place.

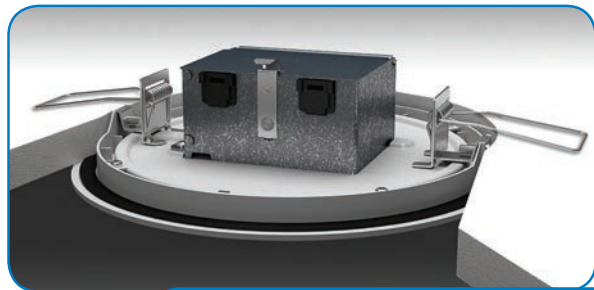

**no housing or jbox required**

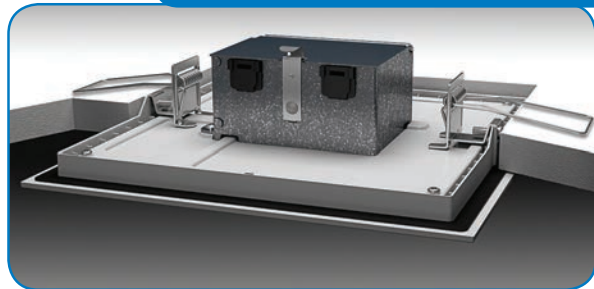

## SLD

### 4" and 6" surface LED downlight

Halo Surface LED Downlight (SLD) incorporates WaveStream™ technology to create an ultra-low profile 4" and 6" surface mounting luminaire with the performance and look of a traditional downlight. SLD is designed for installation in many square, octagon, or round junction boxes. Supply wire adapter with LED quick wiring connector included. Suitable for residential or commercial installations. Ideal for storage areas, attics and basements; and may be used in 4", 5" and 6" recessed downlights. Suitable for use in clothes closets when installed with NEC® 410.16 spacing requirements. The included retrofit kit's dedicated LED wiring connector meets high efficacy code requirements.





**SLD4**



**SLD4058xxWH** 4" surface LED downlight, 80 CRI

**SLD4059xxWH** 4" surface LED downlight, 90 CRI

**SLD4058xxWHJB** 4" surface LED downlight, 80 CRI, junction box mount only

**SLD4059xxWHJB** 4" surface LED downlight, 90 CRI, junction box mount only

**600 lumen**

**SLD6068xxWH** 6" surface LED downlight, 600 lumen, 80 CRI

**SLD6069xxWH** 6" surface LED downlight, 600 lumen, 90 CRI

**SLD6068xxWHJB** 6" surface LED downlight, 600 lumen, 80 CRI, junction box mount only

**SLD6069xxWHJB** 6" surface LED downlight, 600 lumen, 90 CRI, junction box mount only

**xx** - **27**=2700K, **30**=3000K, **35**=3500K, **40**=4000K



**SLD6**



**1200 lumen**

**SLD6128xxWH** 6" surface LED downlight, 1200 lumen, 80 CRI

**SLD6129xxWH** 6" surface LED downlight, 1200 lumen, 90 CRI

**1200 lumen - universal voltage (120V-277V)**

**SLD6128xxWHUNVJB** 6" surface LED downlight, 1200 lumen, 80 CRI, universal voltage 120V-277V, junction box mount only

**SLD6129xxWHUNVJB** 6" surface LED downlight, 1200 lumen, 90 CRI, universal voltage 120V-277V, junction box mount only

**Designer trims (order separately)**



**SLD4TRMWH**  
**SLD6TRMWH**  
white (paintable)



**SLD4TRMTBZ**  
**SLD6TRMTBZ**  
tuscan bronze



**SLD4TRMSN**  
**SLD6TRMSN**  
satin nickel

**Junction box accessories (order separately)**



**SLD4EXT**  
4" Surface LED  
spacer ring



**SLD4RAD**  
4" SLD round surface  
j-box adapter



**SLD6EXT**  
6" Surface LED  
spacer ring



**SLD6RAD**  
6" SLD round surface  
j-box adapter



**SLD6SADPLT**  
6" SLD square surface  
adapter plate

## H4 LED downlight system

Halo H4 LED downlight collection is a three-part system that consists of a 4" downlight housing, light engine module, and trim to be installed according to the pace of the project. The H4 collection is offered in 90 CRI, R9 > 50, with four LED light engines, accepts 16 different trims including reflector, baffle and lensed. Adjustable gimbal light engines feature aiming up to 35° tilt, and interchangeable reflector in 25°, 35°, and 55° beam. Housings are offered in Insulated Ceiling (IC) and Non-Insulated Ceiling (Non-IC), both in Air-Tite™ models that include dimmable LED drivers. H4 LED is ENERGY STAR® certified and can be used for California Title 24, and IECC High Efficacy compliance with designated LED modules and LED trims. Halo 4" LED downlights save energy, without sacrificing performance.



## H4 adjustable gimbal and light engine

Round and square gimbal styles with interchangeable beam reflectors



**ELG4069xx WH/SN/TBZ**  
round adjustable LED light engine



**ELSG4069xx WH/SN/TBZ**  
square adjustable LED light engine

**xx** - 27=2700K, 30=3000K, 35=3500K, 40=4000K  
**WH**=White, **SN**=Satin Nickel, **TBZ**=Tuscan Bronze

### TL412RK

gimbal reflector kit (optional)



25° Reflector  
(Included)



35° Flood  
Reflector



50° Wide  
Flood Reflector

### Compatible LED housings

**H457ICAT1E** - ICAT new construction, 120V

**H457RICAT1E** - ICAT remodel, 120V

**H457TATE010** - Non-IC new construction, UNV (120V-277V)

**H457TCPE010** - Non-IC new construction, chicago plenum, UNV (120V-277V)

**H457RTATE010** - Non-IC remodel, UNV (120V-277V)

### Available finishes



**WH**  
White

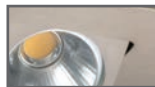

**SN**  
satin nickel



**TBZ**  
tuscan bronze



## H4 light engine and trims



**EL4069xx**  
LED light engine  
(interchangeable trim options)

xx - 27=2700K, 30=3000K, 35=3500K, 40=4000K

### Compatible LED housings

**H457ICAT1E** - ICAT new construction, 120V

**H457RICAT1E** - ICAT remodel, 120V

**H457TATE010** - Non-IC new construction, UNV

**H457TCPE010** - Non-IC new construction,  
chicago plenum, UNV

**H457RTATE010** - Non-IC remodel, UNV

### TL408

Solite® regressed flat lens square baffle



#### TL408WHWB

white baffle and trim with Solite® lens



#### TL408WHBB

black baffle, white trim with Solite® lens



#### TL408SNBB

black baffle, satin nickel trim with Solite® lens



#### TL408TBZBB

black baffle, tuscan bronze trim with Solite® lens

### TL410

deep regressed dome lens reflector



#### TL410WH

white reflector and trim



#### TL410SBK

specular black reflector, white trim



#### TL410SC

specular clear reflector, white trim



#### TL410H

haze reflector, white trim



#### TL410SN

satin nickel reflector and trim



#### TL410TBZ

tuscan bronze reflector and trim

### TL411

deep regressed dome lens baffle



#### TL411WB

white baffle and trim

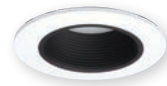

#### TL411BB

black baffle, white trim



## TL402

Solite® regressed flat lens reflector



**TL402WHS**  
white reflector and trim



**TL402HS**  
haze reflector, white trim



**TL402SBKS**  
specular black reflector, white trim



**TL402SN**  
satin nickel reflector and trim



**TL402SCS**  
specular clear reflector, white trim



**TL402TBZ**  
tuscan bronze reflector and trim

## TL402

Solite® regressed flat lens baffle

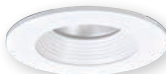

**TL403WB**  
white baffle and trim



**TL403BB**  
black baffle, white trim

## TL400

Thin profile designer trim rings



**TL400WH**  
white trim ring



**TL400SBK**  
black trim ring



**TL400SN**  
satin nickel trim ring



**TL400TBZ**  
tuscan bronze trim ring



**TL400PC**  
polished chrome trim ring

## TL409

wall wash



**TL409WW**  
semi-specular reflector with wall wash optic, diffusing lens, white trim



**TL409WHWW**  
white reflector with wall wash optic, diffusing lens, white trim

## TL422

polymer "dead front" shower trim



**TL422PS**  
white polymer baffle and ring with prismatic clear polymer lens

# HL6

## ALLSLOPE LED recessed lighting

Featuring unique interchangeable beam-forming optics, full range dimming, multiple color temperatures and trim options, the Halo HL6 AllSlope LED 6" downlight system is specifically designed for slope ceilings with pitch aiming from 2/12 (10 degrees) to 12/12 (45 degrees). The innovative design allows the LED light engine full adjustment capability so it can be aimed straight down in accordance with the ceiling pitch, resulting in outstanding performance and appearance. The three piece system consists of a 6-inch aperture housing, available in 1200 lumen series or 1800 lumen series; LED light engines are offered with 90 CRI (R9>50) in 2700K, 3000K, 3500K, 4000K; and available with three interchangeable optics. The trim selection is from a full line of slope ceiling trims including reflectors, baffles, and lens choices.







Halo AllSlope LED housing



Halo AllSlope LED light engine (1200 or 1800 Series)



interchangeable lens



Halo slope trim

## HL6 LED light engines



### HLM69xx

AllSlope LED light engine (interchangeable lens optics)

xx - 27=2700K, 30=3000K, 35=3500K, 40=4000K

## Compatible LED housings

**HL612ICAT** - ICAT new construction, 120V

**HL618TAT** - Non-IC new construction, air-tite, UNV

**HL618TCP** - Non-IC new construction, Chicago plenum, UNV

## Lens optic selection



**HL6NFL**  
narrow flood (NFL) lens



**HL6FL**  
flood (FL) lens



**HL6WFL**  
wide flood (WFL) lens



## HL6 AllSlope housings and trims

**70**

lens and diffuser



**70P**

albalite glass lens, white metal trim



**70PS**

albalite glass lens, white polymer trim, wet location



**70SNS**

albalite glass lens, satin nickel polymer trim, wet location

**71**

drop glass lens and diffuser



**71P**

drop opal glass lens, white metal trim



**71PS**

drop opal glass lens, white polymer trim, wet location "dead front" showerlight

**6160**

drop opal plastic lens



**6160WH**

drop opal plastic lens, white plastic trim

**6162**

drop opal plastic lens



**6162WH**

drop opal plastic lens with upper reflector, white plastic trim



**73**

fresnel glass lens and diffuser



**73P**

drop opal plastic lens, white metal trim



**73PS**

drop opal plastic lens, white polymer trim,  
wet location "dead front" showerlight

**455**

reflector



**455SC**

specular clear reflector, white trim



**455H**

semi-specular haze reflector, white trim



**455SN**

satin nickel reflector and trim

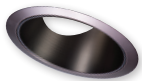

**455TBZ**

tuscan bronze reflector and trim

**456**

Coilex® baffle



**456W**

white coilex baffle and trim



**456P**

black coilex baffle, white trim



## E26 expanded collection

Halo has expanded its Fit-All concept with a new collection of 4-Inch, 5-inch and 6-inch housings and trims designed for the new generation of E26 screwbase halogen, LED, and CFL lamps; with a focus on value, streamlined design, and exclusive installation-friendly features.

With continued nationwide adoption of new E26 screw base lamps in LED, CFL, and halogen technologies; Halo has expanded the line with compatible new trim and housing designs. The expanded E26 series is ideal for both residential and light commercial downlighting applications with its versatile installation, attractive design, universally accepted E26 screw base, and capability to employ new energy efficient lamps.

New trims feature a consistent design style in an all-inclusive offering of full-cone and half-cone reflectors and baffles; gimbal and eyeball directionals; open and lensed wet location with “dead-front” options.

Housings feature efficient installation capability in a compact-sized frame with an offering of socket-bracket and no-socket-bracket models. New installation features include a repositionable junction box with hinged door for flexibility in tight spaces; All Nail! bar hangers with new Q-Channel interlocking bars that pass-thru for increased stability and tool-less shortening. Remodels feature an exciting new retention method of speed clamps with locking tabs that adjust for ceilings from 3/8” – 2”.







## 4" housings

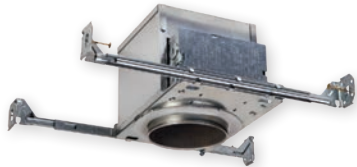

### E4ICATSB

4" ICAT new construction, air-tite



### E4TATSB

4" Non-IC new construction, air-tite



### E4RTATSB

4" Non-IC remodel, air-tite





## 4" trims

**4001**

step plastic baffle



**4001WB**

white baffle and trim



**4001BB**

black baffle, white trim

**4002**

eyeball, 30° tilt



**4002WH**

white eyeball

**4003**

reflector



**4003SC**

specular clear, white trim

**4010**

metal baffle



**4010WB**

white baffle and trim



**4010BB**

black baffle, white trim

**4055**

glass lens



**4055WH**

glass lens, white trim

**4013**

full cone baffle



**4013WB**

white baffle and trim



**4013BB**

black baffle and white trim



## 5" housings



### **E5ICAT**

5" ICAT new construction

### **E5ICATNB**

5" ICAT new construction, no socket bracket

### **E550ICAT**

5" LED ICAT new construction



### **E5RICAT**

5" ICAT remodel

### **E550RICAT**

5" LED ICAT remodel



### **E5TAT**

5" Non-IC new construction

### **E5TATNB**

5" Non-IC new construction, no socket bracket



### **E5RTAT**

5" Non-IC remodel

## 5" reflectors

**5107**

specular reflector



**5107SC**

specular reflector, white trim

**5120**

full cone reflector



**5120WH**

white reflector and trim

**5121**

shallow full cone reflector



**5121WH**

white reflector and trim



**5120SN**

satin nickel reflector and trim



**5120TBZ**

tuscan bronze reflector and trim



## 5" baffles

**5102**

tapered metal baffle

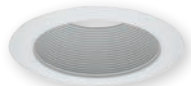

**5102WB**

white baffle and trim

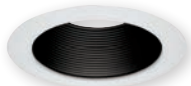

**5102BB**

black baffle and white trim

**5109**

coilex® tapered baffle



**5109WB**

white plastic tapered coilex baffle and trim



**5109BB**

black plastic tapered coilex baffle and white trim



**5109BKBB**

black plastic tapered coilex baffle and trim

**5110**

perftex™ baffle



**5110WB**

white perftex baffle and trim



**5110BB**

black perftex baffle and white trim



**5110BKBB**

black perftex baffle and trim

**5125**

full cone baffle



**5125WB**

white baffle and trim

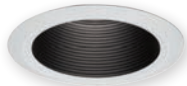

**5125BB**

black baffle and white trim

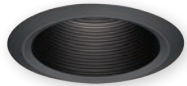

**5125BKBB**

black baffle and trim

**5126**

shallow full cone baffle



**5126WB**

white baffle and trim



**5126BB**

black baffle and white trim

## 5" adjustables

**5130**

eyeball, 35° tilt, PAR30

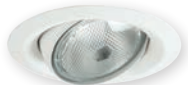

**5130WH**

white eyeball and trim

**5165**

gimbal, 25° tilt, PAR30



**5165WH**

white gimbal and trim



**5165SN**

satin nickel gimbal and trim

**5222**

regressed adjustable gimbal, 30° tilt



**5222WB**

white baffle and white trim



**5222SC**

specular clear reflector and white trim

**5135**

eyeball, 35° tilt, PAR20



**5135WH**

white eyeball and trim



**5165BK**

black gimbal and trim



**5165TBZ**

tuscan bronze gimbal and trim



**5222BB**

black baffle and white trim

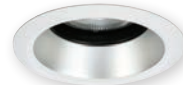

**5222H**

haze reflector and white trim

## 5" showerlights

**5145\***

open wet location shallow reflector



**5145WH**  
white



**5145SN**  
satin nickel



**5145TBZ**  
tuscan bronze

**5146\***

open wet location full reflector



**5146WH**  
white



**5146SN**  
satin nickel



**5146TBZ**  
tuscan bronze

**5150**

frost glass lens



**5150WH**  
frost lens, white plastic trim



**5150SN**  
frost lens, satin nickel  
plastic trim



**5150TBZ**  
frost lens, tuscan bronze  
plastic trim





**5162**

drop opal plastic lens



**5162WH**

drop opal plastic lens with upper reflector, white plastic trim



**5230**

squirele frost glass lens, metal trim



**5230AH**

frost glass lens, aluminum haze squirele trim



**5230PN**

frost glass lens, polished nickel squirele trim



**5230SN**

frost glass lens, satin nickel squirele trim



**5230TBZ**

frost glass lens, tuscan bronze squirele trim

**5255**

soft square, frost glass lens



**5255WH**

frost glass lens, white plastic trim



**5255SN**

frost glass lens, satin nickel plastic trim



**5255TBZ**

frost glass lens, tuscan bronze plastic trim

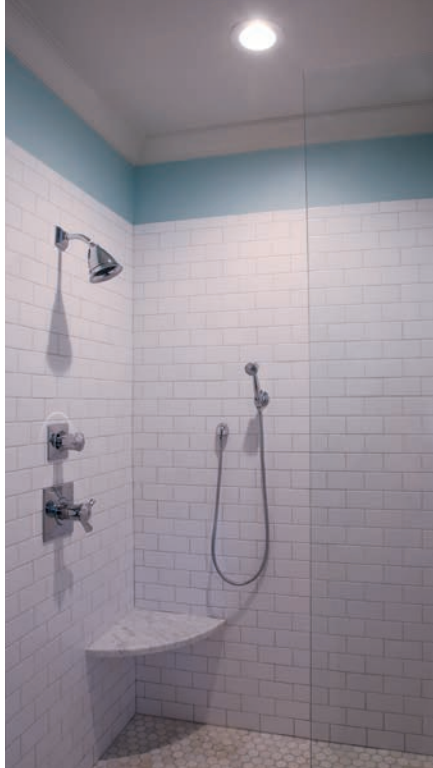

## 5" open and splay

**5175**

open, wide trim



**5175WH**

white

**5176** open, wide trim,  
socket supporting



**5176WH**

white

**5185**

splay



**5185WH**

white

**5186**

splay, socket supporting



**5186WH**

white



**5175SN**

satin nickel



**5176SN**

satin nickel



**5185SN**

satin nickel



**5186SN**

satin nickel



**5175TBZ**

tuscan bronze



**5176TBZ**

tuscan bronze



**5185TBZ**

tuscan bronze



**5186TBZ**

tuscan bronze

## 6" housings



### **E71CAT**

6" ICAT new construction

### **E71CATNB**

6" ICAT new construction, no socket bracket

### **E750ICAT**

6" LED ICAT new construction



### **E7RICAT**

6" ICAT remodel

### **E750RICAT**

6" LED ICAT remodel



### **E7TAT**

6" Non-IC new construction

### **E7TATNB**

6" Non-IC new construction, no socket bracket



### **E7RTAT**

6" Non-IC remodel

## 6" shallow housings



### E27ICAT

6" shallow ICAT new construction

### H2750ICAT

6" shallow ICAT LED new construction



### E27RICAT

6" shallow ICAT remodel

### H2750RICAT

6" shallow ICAT LED remodel



### E27TAT

6" shallow Non-IC new construction



### E27RTAT

6" shallow Non-IC remodel



## 6" reflectors

**6106**

straight reflector

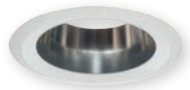

**6106SC**

specular reflector, white trim

**6107**

tapered reflector



**6107SC**

specular reflector, white trim

**6120**

full cone reflector



**6120WH**

white reflector and trim



**6120SN**

satin nickel reflector and trim



**6120TBZ**

tuscan bronze reflector and trim

**6121**

shallow full cone reflector



**6121WH**

white reflector and trim



## 6" baffles

### 6100

tapered metal baffle



### 6100WB

white baffle and (2) white trims  
(wide and narrow included)

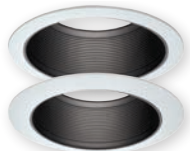

### 6100BB

black baffle and (2) white trims  
(wide and narrow included)

### 6101

straight metal baffle



### 6101WB

white baffle and (2) white trims  
(wide and narrow included)

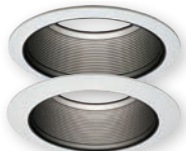

### 6101BB

black baffle and (2) white trims  
(wide and narrow included)

### 6102

tapered metal baffle



### 6102WB

white baffle and trim

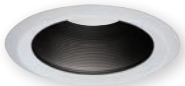

### 6102BB

black baffle and white trim

### 6103

straight metal baffle



### 6103WB

white baffle and trim



### 6103BB

black baffle and trim

### 6108

coilex® straight baffle

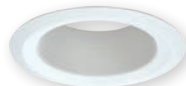

### 6108WB

white plastic straight coilex baffle  
and trim

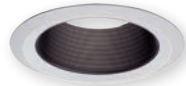

### 6108BB

black plastic straight coilex baffle  
and trim



### 6108BKBB

black plastic straight coilex baffle  
and trim



**6109**

coilex® tapered baffle



**6109WB**

white plastic tapered coilex baffle and trim



**6109BB**

black plastic tapered coilex baffle and white trim



**6109BKBB**

black plastic tapered coilex baffle and trim

**6110**

perftex™ baffle



**6110WB**

white perftex baffle and trim



**6110BB**

black perftex baffle and white trim



**6110BKBB**

black perftex baffle and trim

**6125**

full cone with baffle



**6125WB**

white baffle and trim

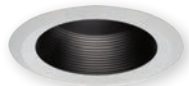

**6125BB**

black baffle and white trim

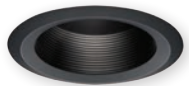

**6125BKBBB**

black baffle and trim

**6126**

shallow full cone with baffle



**6126WB**

white baffle and trim



**6126BB**

black baffle and white trim

## 6" adjustables

**6130**

eyeball, 35° tilt PAR30



**6130WH**

white eyeball and trim

**6170**

gimbal, 25° tilt PAR38



**6170WH**

white gimbal and trim



**6170SN**

satin nickel gimbal and trim



**6170BK**

black gimbal and trim



**6170TBZ**

tuscan bronze gimbal and trim



**6215**

double gimbal 35°-50° tilt, PAR38



**6215WH**  
white gimbal and trim



**6215SN**  
satin nickel gimbal and trim



**6215BK**  
black gimbal and trim



**6215TBZ**  
tuscan bronze gimbal and trim

**6222**

regressed adjustable, 45° tilt



**6222WB**  
white baffle and white trim



**6222BB**  
black baffle and white trim



**6222SC**  
specular clear reflector and white trim

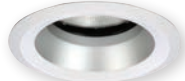

**6222H**  
haze reflector and white trim



## 6" showerlights

**6145\***

open wet location shallow reflector



**6145WH**  
white



**6145SN**  
satin nickel



**6145TBZ**  
tuscan bronze

**6146\***

open wet location full reflector



**6146WH**  
white



**6146SN**  
satin nickel



**6146TBZ**  
tuscan bronze

**6150**

frost glass lens



**6150WH**  
frost lens, white plastic trim



**6150SN**  
frost lens, satin nickel  
plastic trim



**6150TBZ**  
frost lens, tuscan bronze  
plastic trim

**6160**

drop opal plastic lens



**6160WH**  
drop opal plastic lens,  
white plastic trim

**6162**

drop opal plastic lens



**6162WH**  
drop opal plastic lens with upper  
reflector, white plastic trim

**6230**

squircle frost glass lens, metal trim



**6230AH**

frost glass lens,  
aluminum haze squircle trim



**6230PN**

frost glass lens,  
polished nickel squircle trim



**6230SN**

frost glass lens,  
satin nickel squircle trim



**6230TBZ**

frost glass lens,  
tuscan bronze squircle trim

**6255**

soft square, frost glass lens



**6255WH**

frost glass lens, white  
plastic trim



**6255SN**

frost glass lens, satin nickel  
plastic trim



**6255TBZ**

frost glass lens, tuscan bronze  
plastic trim



**Eaton**

1121 Highway 74 South  
Peachtree City, GA 30269  
P: 770-486-4800  
[www.eaton.com/lighting](http://www.eaton.com/lighting)

Canada Sales  
5925 McLaughlin Road  
Mississauga, Ontario L5R 1B8  
P: 905-501-3000  
F: 905-501-3172

**Our Lighting Product Lines**

Halo  
Halo Commercial  
Portfolio  
IRiS  
RSA  
Metalux  
Corelite  
Neo-Ray  
Fail-Safe  
MWS  
Ametrix  
Shaper  
io  
Lumark  
McGraw-Edison  
Invue  
Ephesus  
Lumière  
Streetworks  
AtLite  
Sure-Lites

**Our Controls Product Lines**

Greengate  
iLumin  
Zero 88  
Fifth Light Technology  
iLight (International Only)

**Connected Lighting Systems**

LumaWatt Pro  
WaveLinx  
Distributed Low-Voltage  
Power  
ConnectWorks



*Powering Business Worldwide*

**Eaton**

1121 Highway 74 South  
Peachtree City, GA 30269  
P: 770-486-4800  
[www.eaton.com/lighting](http://www.eaton.com/lighting)

© 2017 Eaton  
All Rights Reserved  
Printed in USA  
Publication No. BR518045EN  
December 2017

Eaton is a registered trademark.

All other trademarks are property  
of their respective owners.